

Planipes: Mobile Foot Pressure Analysis*

Samuel Pfaffen, Philipp Sommer, Christian Stocker, Roger Wattenhofer, and Samuel Welten
Computer Engineering and Networks Laboratory
ETH Zurich, Switzerland

{pfaffesa, sommer, chstocke, wattenhofer, welten}@tik.ee.ethz.ch

Abstract

Analyzing foot pressure is helpful in clinical diagnosis. Possible applications include the diagnosis of back injuries, prevention of diabetic foot ulceration, and adaptation of insoles for orthopedic applications. Consequently, several approaches to measure foot pressure distributions exist. However, traditional systems exhibit one common drawback: They are non-mobile or at least obtrusive and therewith influence the measurement. In the case of stationary pressure plates, people are only able to measure the foot pressure distribution in an unnatural context. The few available portable systems feature a lot of cables and large data processing computers, which render them unusable for everyday activities or long term measurements. To address these issues we have implemented *Planipes*, a mobile and versatile foot pressure measurement platform. It consists of a small sensor module that measures foot pressure distribution in real time and a smartphone application that allows to visualize, record, and analyze the data. Both parts are wirelessly connected through Bluetooth. Our system allows to unobtrusively measure foot pressure in real time during everyday activities, and to give feedback to the user. In contrast to existing systems it allows to measure foot pressure of a person over a longer period and in a natural environment, without influencing or impeding the user.

Keywords

Personal Health Monitoring, Wearable Sensor, Foot Pressure

Categories and Subject Descriptors

J.3 [Life and Medical Sciences]: Health.

*The authors of this paper are alphabetically ordered.

Permission to make digital or hard copies of all or part of this work for personal or classroom use is granted without fee provided that copies are not made or distributed for profit or commercial advantage and that copies bear this notice and the full citation on the first page. To copy otherwise, to republish, to post on servers or to redistribute to lists, requires prior specific permission and/or a fee.
mHealthSys '11, Nov 1, Seattle, Washington, USA
Copyright 2011 ACM 978-1-4503-0684-3/11/11 ...\$5.00

1 Introduction

For a long time, mobile health was essentially an oxymoron, as often health systems were bulky machines and therefore immobile. Only recently, with the popular success of mobile phones as an inexpensive computing platform, it became meaningful to consider mobile health systems as an alternative. This recent trend was particularly driven by developing countries, primarily to bring the cost of health systems down.

In this paper we study a mobile health system that is not motivated by cost, but rather by mobility itself, as we want to measure motion sequences in everyday life. To some degree, in 2011 one may even be surprised that somebody considered immobile health systems for curing such a strictly mobile issue!

Although most people pay little attention to their feet, feet have to withstand physical strain occurring when standing for hours, carrying heavy objects, or moving rapidly during sports. As such, analyzing pressure distributions play an important role in medicine and sports:

- Joggers and long distance runners, for example, have to pay attention that their passion for running does not result in knee problems. Foot pressure measurement during training sessions could show unhealthy forces and help to master a softer and healthier running style. Similarly, skiing instructors often try to teach their students about the right posture. A system that displays the pressure on the student's sole in real time can assist the instructors in this process.
- More serious are medical problems. Because of injuries or diseases to the legs, feet, spine, brain, or inner ear one may develop unhealthy walking patterns. In medical terms the walking pattern of a person is called the gait, e.g. propulsive, scissors, spastic, steppage, or waddling gait. Often enough, if minor, walking problems occur even without anybody noticing. Abnormal gait may be treated by different means, including physical therapy such as orthopedic insoles.

Physicians often use a visual procedure to get a first diagnosis. Observing a walking patient, the physician can try to determine the cause of the disorder. Just by observation, an experienced physician can already make a good diagnosis.

However, pure observation has drawbacks. Clearly, visual evaluation may be subjective. Moreover, simple ob-

servations lack quantitative statements. Using foot pressure measurements, a doctor can reasonably supplement her way of making a diagnosis. Thereby, the foot's force on a surface is measured by pressure sensitive sensors. Essentially, the patient is asked to walk across a pressure measuring plate, hitting the plate more or less in the middle, in a "natural" walking motion.¹ Instead, it would be better to have a truly mobile system that does not hinder the patient in her natural movement, and can possibly record foot pressure throughout the day. In other words, instead of having the sensors on the floor, they should rather be directly on the foot. The analysis of the data can be done in real-time or off-line. Important however is that the system does not affect the patient's natural gait. Currently used systems are either immobile, or simply impractical.

Contributions. The main contribution of this paper is a versatile and mobile foot pressure distribution measurement system called *Planipes*. The proposed system consists of a pair of sensor soles, each connected to a small sensor board, and a smartphone application. The sensor data is transmitted from the sensor boards to the smartphone using Bluetooth. The small form factor and the wireless communication of the components allow to conduct dynamic measurements with minimal effect on a person's feet. Opposed to existing systems, the use of *Planipes* is not restricted to one location, does not require time-consuming and disturbing wiring of the person, and does not require wearing an additional portable computer. Additionally, to evaluate the sensor data, a user-friendly smartphone application was implemented for the Android system. The application allows to analyze the data in many different ways, depending on the use-case.

Due to its mobility and unobtrusiveness of our system, a wide range of applications with considerable potential are possible. As mentioned, one field of application is to support the diagnosis of physicians and therapists. Of particular interest are the pressure parameters that cannot be directly determined by observing a patient. However, thanks to the energy efficiency of our system, physicians and therapists can also look at the off-line data of a patient, understanding her natural gait, or checking the effects of a treatment.

2 The Planipes System

The aim of the *Planipes* system is to offer a versatile platform for a broad spectrum of different applications in pedography. Thereby, the focus of our system is to provide a cheap solution for precise measurements without impairing the mobility of the patient. In order to reduce the total costs of the *Planipes* system and to increase its flexibility, we decided to rely on the user's smartphone for data processing, storage and visualization tasks.

2.1 Architecture

The *Planipes* system consists of two parts: two sensor devices and a smartphone application. The pressure distribution at each foot is measured by a pressure-sensitive in-

¹On a personal note, some of us who had this treatment would doubt that it is possible to walk "naturally" in such a test situation; hitting the measure plate after a series of steps just adds to the contrived experience.

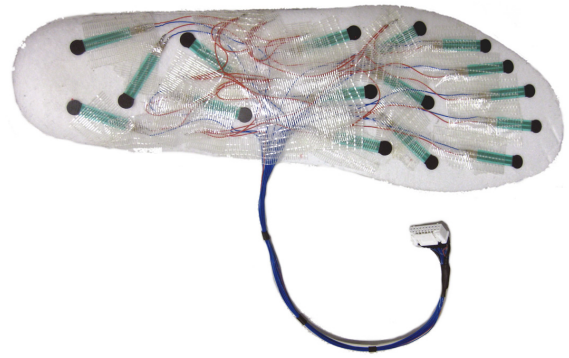

Figure 1. Picture of the bottom side of the *Planipes* insole, which is equipped with 16 force sensing resistors for pressure measurements.

sole, which is connected to a small sensor board. This board controls the sampling procedure of the pressure sensors and communicates with the smartphone over a Bluetooth connection. A dedicated smartphone application is responsible to collect, process and display the measurement data.

2.2 Sensor Insole

The sensor insole has been designed to measure the pressure affecting different regions of the foot. We equipped each insole with 16 force sensing resistors (FSR) as depicted in Figure 1. The placement of these sensors is based on previous FSR-based foot pressure measurement systems (eg. [17]). However, as the precision of the measurement depends on the placement of the sensors, this configuration might be changed by a physician [4], depending on the requirements. The current prototype of the sensor board allows an easy replacement of different insoles through plugging and unplugging.

Each sensor is built from two membranes separated by a small adhesive layer [11]. When a force is applied, a carbon film on the top layer is pressed onto the active area of the bottom layer, resulting in a change of resistance which depends on the force being applied. With an appropriate electronic circuit, this change in resistance can be measured and the corresponding pressure can be calculated. In our system, the FSR is connected in series with a resistor between ground and the supply voltage to form a voltage divider. In order to identify the left and the right insole, a feature for foot side recognition is needed. This was achieved by a different voltage reference in the insoles for the right and left foot.

2.3 Sensor Board

The sensors placed underneath the insole are connected to a printed circuit board with a size of 2.5 x 5 cm, as shown in Figure 2. The core of the board is an Atmel ATmega328 microcontroller, which has 32 KBytes of ROM and 2 KBytes of RAM. A Lithium-Polymer rechargeable battery is used to power the sensor board. The battery can be charged with the integrated USB charger. The voltage at all 16 sensors and the voltage reference for foot side recognition have to be converted into digital values. As the microcontroller is limited

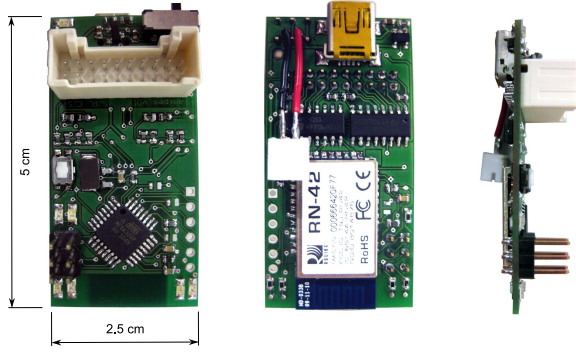

Figure 2. The Planipes sensor board: top, bottom and side view.

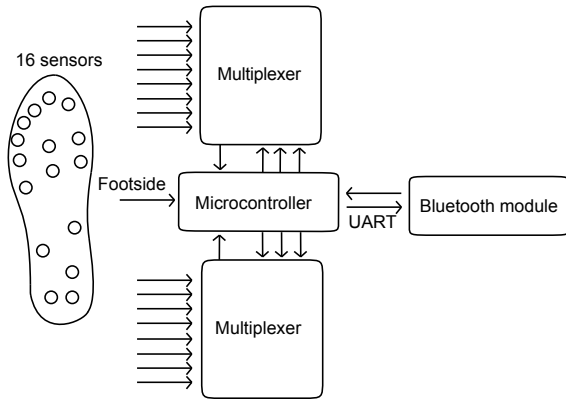

Figure 3. Schematic view of the Planipes sensor board. The resistive sensors are connected to the analog-digital converter of the microcontroller using two multiplexers.

to 8 analog-digital converter (ADC) inputs only, the analog signals are connected to two multiplexer circuits, which receive their control signal from the microcontroller and are connected to two input pins of the microcontroller (see Figure 3).

2.3.1 Data Transfer

The board features a Roving Networks RN-42 low-power Bluetooth module, which provides a serial communication interface between the microcontroller and the phone through the Bluetooth serial port profile (SPP). Furthermore, four LEDs can be used to provide visual feedback to the user about the current operation mode of the system, e.g., to indicate that a Bluetooth connection to the phone has been established.

In normal operation mode, the microcontroller samples the voltage of all 16 sensors in a round-robin scheme. The sensor data are cached temporarily in the memory and sent together with the foot side identification signal in a batch to the Bluetooth module after each round of sampling. In addition to the foot pressure data, the battery voltage is also sent, which allows to estimate the remaining battery life-time on the smartphone. The end of a packet transmission is signaled by a sync-byte, resulting in a total transfer size of 37 Bytes. The Bluetooth module offers a data rate of roughly 240 kbps, i.e., about 30 kBytes/s. Therefore, we can trans-

fer up to 810 full measurements per second, which seems to be more than adequate for most applications. The maximum sample rate of the analog sensor circuits is limited by the switching frequency of the multiplexer and the sampling rate of the analog-digital converter which is around 200 kHz.

2.3.2 Energy Consumption

To measure the energy consumption of a single sensor board with an insole attached, we used a current clamp at the power supply. The current consumption of a board is about 44 mA when a Bluetooth connection is active. Thereby, the Bluetooth module accounts for a large fraction of the current draw while the sampling frequency of the ADC has only a minor influence on the current consumption. Using a standard rechargeable battery with a nominal capacity of 850 mAh the system can be operated for approximately 19 hours.

3 Smartphone Application

In this section we describe the architecture of the Planipes smartphone application implemented in the Android operating system. The application is responsible to handle the communication with the sensor boards over Bluetooth. Incoming sensor measurements are processed and stored on the phone's SD card for offline analysis. Furthermore, the data is visualized on the screen to provide an immediate feedback to the user.

3.1 Data Post-Processing

The force sensing resistors used in the insoles of Planipes exhibit a non-linear dependency between the pressure applied and the resistance measured at the sensor. Therefore, the sensor data has to be post-processed at the smartphone to get the corresponding pressure value. The resistance of the sensor (R_{FSR}) is converted into a 10-bit ADC value (U_{ADC}) according to the voltage divider relation shown in Equation 1, where VCC is the operating voltage of the microcontroller and R_{ref} the value of a reference resistor.

$$U_{ADC}(R_{FSR}) = VCC \cdot \frac{R_{FSR}}{R_{ref} + R_{FSR}} \quad (1)$$

The corresponding value of the applied force can be approximation using the parameters listed in the datasheet of the sensors [11].

3.2 Data Logging

For many application scenarios having offline access to the pressure distribution is helpful for further analysis, especially when monitoring everyday activities. Therefore, the incoming sensor data is also written to a log file located on the SD card of a phone. This is done by a background service, which makes it feasible to use the Planipes system also for long-term observations without making it necessary to run the application in the foreground. Furthermore, the internal sensors of the smartphone, e.g., the accelerometer or the GPS receiver, can provide additional information about the current context of the test subject. The recorded log files can be played back directly in the application. When in the replay mode, the user is able to scroll through the log file, pause and resume the playback, as known from other applications such as a media player.

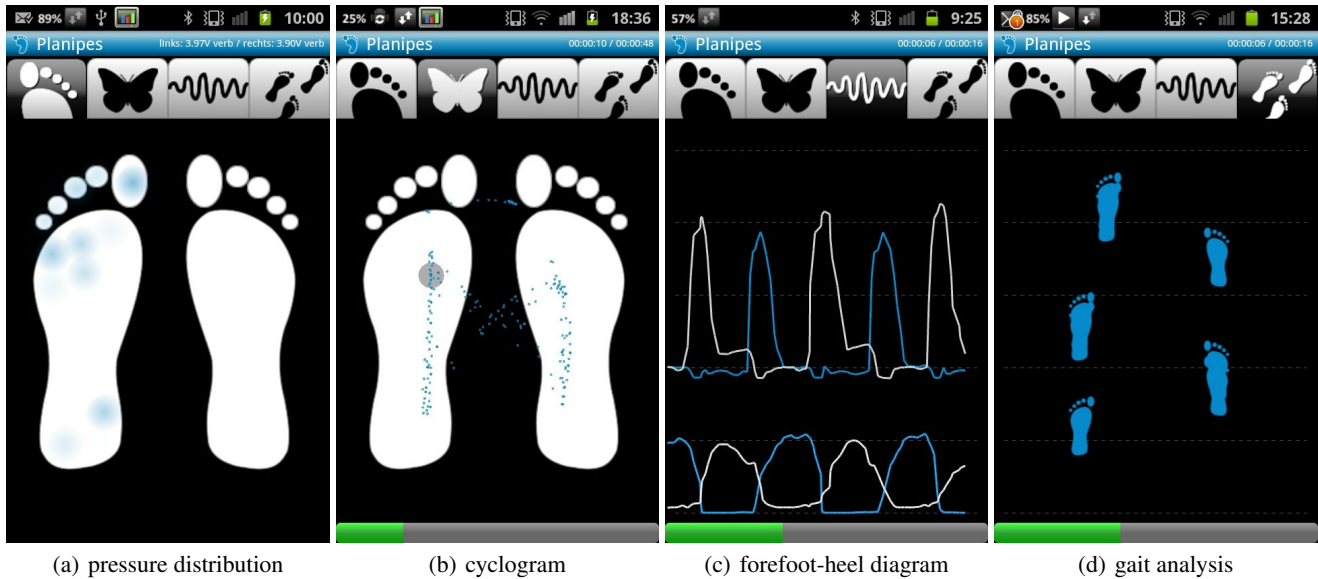

Figure 4. Screenshots of the Planipes application running on an Android smartphone. Using four different screens (pressure distribution, cyclogram, forefoot-heel diagram, and gait analysis) the incoming sensor data can be visualized according to the specific use case.

3.3 Temporal Resolution

An important factor in capturing dynamic foot pressure distributions is the temporal resolution of the measurement data. Depending on the application scenario the sampling frequency can be set in the firmware of the microcontroller. In the prototype implementation of Planipes, the temporal resolution of the data collection, transmission and display is set to 40 Hz.

One limiting factor is the processing speed of the data in the smartphone. We therefore tested the application with two common Android smartphones featuring different computing capabilities. On our faster test device, which is a Samsung Galaxy S2, the sampling frequency can be increased up to 100 Hz, while still being able to record and display accurate data. On the slower test device, which is a HTC Hero, the application starts to lag at 50 Hz, while the display of the data appears fluently at 40 Hz.

4 Case Studies

The Planipes smart phone software aims to provide a versatile tool for foot pressure and gait analysis. We implemented four different data visualization views, that should demonstrate the advantages of using a smartphone as a platform for data processing and user interaction. This section will shortly introduce four exemplary visualization types, among with potential use cases.

4.1 Pressure Distribution

The pressure distribution visualization is depicted in the first screenshot in Figure 4. It illustrates the current pressure on each of the sensors by drawing glowing circles of different intensity. The stronger a circle is visible the higher is the current pressure on the corresponding sensor. This type of visualization is suited for the real time analysis of incorrect posture or the fitting of custom therapeutical insoles.

4.2 Cyclogram

Another type of visualization is the cyclogram depicted in the second screenshot in Figure 4. The cyclogram makes the balance point of a person visible by computing the center of mass of all sensor values. As knowing the balance point is especially interesting in the context of dynamic measurement of gait, the cyclogram visualization plots the balance point over time. In the ideal case this diagram looks similar to a stylized butterfly (see Figure 4). Irregularities in this shape can indicate inappropriate mechanical stress that can cause long term problems.

4.3 Forefoot-Heel-Diagram

In the forefoot-heel diagram, a horizontally advancing diagram with the stress of the heel and the forefoot of both feet is drawn. Thereto, the sensors of the heel and the sensors of the forefoot are averaged. Such a diagram can help runners to detect unhealthy running patterns that can lead to knee damages.

4.4 Gait Analysis

The gait analysis displays a foot icon on a vertically advancing axis once the sum of certain sensors exceeds a threshold value. To make small steps distinguishable from each other, every step is drawn on a horizontally different position. During a longer phase of standing, two continuous lines are visible.

4.5 Offline Activity Analysis

To demonstrate the power of the offline analysis, we recorded four different activities and plotted the front-heel pressure distribution of both feet. The shoes of a test subject were equipped with the Planipes insole (see Figure 5) and we used the logging functionality of the smartphone software to record pressure data. The plots are shown in Figure 6. In the



Figure 5. The Planipes sensor board is attached on the instep of the test person’s shoe.

top plot the test subject is walking. One can see that the person is putting more weight to the heel of the foot. In comparison to the next plot, which was recorded during running, the pressure curve is much smoother and the different lengths of the ground contacts are clearly visible. Even more pronounced differences can be seen in the lower two plot pairs. When walking up the stair, the test subject applies most of the force with the left leg, whereas when walking down, the highest pressure peaks are recorded on the right foot.

5 Related Work

Numerous foot pressure measurement and gait analysis systems were developed for different medical applications and sport activities. In the following section, we give a short overview on the evolution of pressure analysis systems. Furthermore, we present systems that focus on different aspects and applications, and we discuss how they have influenced the development of Planipes.

Medical Systems. Foot pressure measurement has been a useful tool in medical diagnostics for a long time. Betts et al. [1] state that the first qualitative foot pressure measurements for clinical purposes were made towards the end of the nineteenth century. It began with simple analogue pressure measurement systems, made of a deformable substances or a glass plate. In the nineteen-sixties several researchers began to develop more accurate electronic systems [1, 12]. With the continuous miniaturization of electronics, the first portable, computer-based, foot pressure measurements systems evolved. An example of such a system is the computerized insole of Randolph et al. [15]. Despite the fact that the sensing unit was portable, it still relied on a wired connection to a stationary computer, therewith limiting the scope of applications to laboratory experiments.

In the last decade wearable gait analysis systems were developed that measured some basic foot pressure amongst many other parameters [14, 9, 5]. These devices have proven to be very useful in detecting abnormal gaits or fitting prostheses. However, they still rely on a connection to a computer or require chunky pieces of electronics on the shoes or attached to the hips. In modern orthopedics, the digital display of the feet’s pressure distribution (pedography) has become an indispensable element of diagnosis. The use of

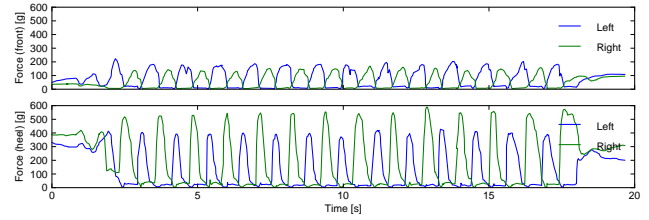

(a) Test subject is walking.

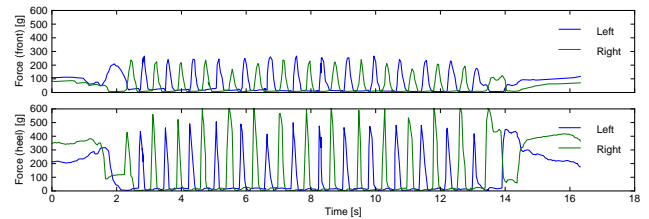

(b) Test subject is running.

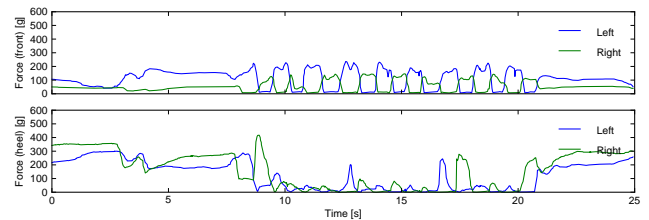

(c) Test subject is walking up a staircase.

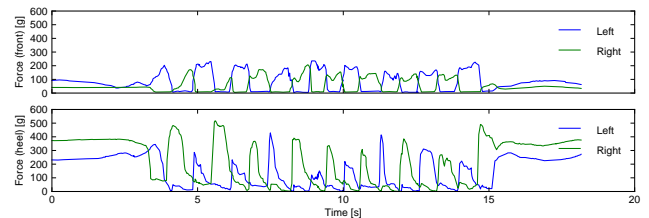

(d) Test subject is walking down a staircase.

Figure 6. Traces for the front/heel pressure distribution during different activities.

force sensing resistors in the context of foot pressure measurements has been studied extensively [10]. A system that measures the foot pressure on the one hand and is able to automatically adjust an orthotic insole on the other hand is *Smart Orthotics* [19]. Despite the general technical soundness of this system, its size does not allow to use it in universal foot pressure measurement settings. In other applications, sensing foot pressures can help to monitor the risk for amputations caused by a diabetic foot [20, 6]. Dabiri et al. ([6]) described an approach similar to ours, using a few pressure sensors and acceleration sensors which send their data to a portable device for post processing. The wireless transmission of the data is realized over an existing medical sensor platform called *MedNode*, which renders the whole system quite expensive.

Compared to the approaches presented above, our system

does not necessarily solve previously unsolved problems, but shows how smartphones together with small and cheap hardware can partially replace expensive medical systems.

Sports. Beside of the medical applications of foot pressure measurement there are various applications in sports. For example, one can use such a system to try jogging shoes for their wearing comfort or detect inefficient motion patterns in endurance sports. For sport applications it is crucial that the system does not influence the wearing person by impeding the gait or requiring to carry around much additional weight. Analysis and visualization should be provided in real time and offline on a computer. Two big sports article manufacturers have recognized this need for such systems. Nike (together with Apple) with the *Nike + iPod Sports Kit* and Adidas with the *miCoach PACER* and the according application *miCoach Mobile* both offer basic unobtrusive accelerometer recording. These systems provide, together with logging the movement data, the possibility to get an acoustic feedback when running. That way, the application can react to decreasing effort by playing an appropriate song to motivate the jogger. However, these devices lack the ability to measure pressure and are therefore not suited to detect unhealthy motion or inappropriate mechanical stress.

Smartphone Based Sensing. Processing sensor data on a smartphone allows to easily create user interfaces tailored for different applications. Smartphones have shown to be an ideal platform to post-process data and to forward it to servers [18]. Furthermore, the already available sensors in a smartphone allow to intelligently combine the sensed data with context information from the phone, e.g., [3, 13, 16, 8]. Recently, Fahrni et al. [7] have proposed a wearable UV radiation recording and warning system for medical purposes. Similar to Planipes, they use the smartphone to provide application-adapted user interfaces. An additional requirement for most applications is the acceptance of the measurement system by the users. This can be achieved through visually appealing display of the data and a user-friendly interface. Brand and Crowninshield hereto define a series of important criteria [2]. As modern smart phones feature touch screen input and offer the possibility to easily design graphical user interfaces, smart phones are a well suited platform for sensor interaction [18].

6 Conclusions and Outlook

We have presented a system to wirelessly record and analyze foot pressure distribution. Due to the decision to process and log the data on the user's smart phone, the wearable sensor could be designed in a small form factor and at low cost. Despite the use of off-the shelf components, Planipes allows to measure foot pressure distribution in a spatial density and sampling frequency that renders it useful for several applications in sports and medicine. Its small size and light weight improve the state of the art towards foot pressure measurement systems that do not impede the user or influence the gait. Future version of the Planipes system could be built with custom-made force-sensitive sensors in the insole, which would allow to provide an even higher spatial resolution.

7 References

- [1] R. Betts, C. Franks, T. Duckworth, and J. Burke. Static and dynamic foot-pressure measurements in clinical orthopaedics. *Medical and Biological Engineering and Computing*, 18(5):674–84, 1980.
- [2] R. Brand and R. Crowninshield. Comment on criteria for patient evaluation tools. *J. Biomech.*, 14(9):655, 1981.
- [3] J. Burke, D. Estrin, M. Hansen, A. Parker, N. Ramanathan, S. Reddy, and M. Srivastava. Participatory Sensing. In *Proceedings of the Workshop on World-Sensor-Web (WSW)*, pages 1–5, 2006.
- [4] P. R. Cavanagh, F. H. Jr, and J. Perry. In-shoe plantar pressure measurement: a review. *The Foot*, 2(4):185 – 194, 1992.
- [5] M. Chen, B. Huang, and Y. Xu. Intelligent shoes for abnormal gait detection. In *ICRA*, pages 2019–2024, 2008.
- [6] F. Dabiri, A. Vahdatpour, H. Noshadi, H. Hagopian, and M. Sarrafzadeh. Electronic orthotics shoe: Preventing ulceration in diabetic patients. In *EMBS*, Aug. 2008.
- [7] T. Fahrni, M. Kuhn, P. Sommer, R. Wattenhofer, and S. Werten. Sundroid: Solar Radiation Awareness with Smartphones. In *Ubicomp*, 2011.
- [8] R. Ganti, N. Pham, H. Ahmadi, S. Nangia, and T. Abdelzaher. GreenGPS: A participatory sensing fuel-efficient maps application. In *Proceedings of the 8th international conference on Mobile systems, applications, and services*, pages 151–164, 2010.
- [9] M. Hannula, A. Sakkinen, and A. Kylmanen. Development of emfi-sensor based pressure sensitive insole for gait analysis. In *International Workshop on Medical Measurement and Applications (MEMEA)*, pages 1–3, 2007.
- [10] G. Hegewald. *Ganganalytische Bestimmung und Bewertung der Druckverteilung unterm Fuss und von Gelenkwinkelverläufen*. Ph.d. thesis, Humboldt University Berlin, 1999.
- [11] Interlink Electronics. Force Sensing Resistors - Integration Guide. <http://www.interlinkelec.com/>, Sept 2010.
- [12] M. Lord. Foot pressure measurement: A review of methodology. *Journal of Biomedical Engineering*, 3(2):91 – 99, 1981.
- [13] E. Miluzzo, N. D. Lane, K. Fodor, R. Peterson, H. Lu, M. Musolesi, S. B. Eisenman, X. Zheng, and A. T. Campbell. Sensing meets Mobile Social Networks: The Design, Implementation and Evaluation of the CenceMe Application. In *Sensys*, 2008.
- [14] S. J. Morris and J. A. Paradiso. Shoe-integrated sensor system for wireless gait analysis and real-time feedback. In *Joint EMBS/BMES*, 2004.
- [15] A. Randolph, M. Nelson, M. deAraujo, R. Perez-Millan, and T. Wynn. Use of computerized insole sensor system to evaluate the efficacy of a modified ankle-foot orthosis for redistributing heel pressures. *Archives of physical medicine and rehabilitation*, 80(7):801–804, 1999.
- [16] S. Reddy, K. Shilton, G. Denisov, C. Cenizal, D. Estrin, and M. Srivastava. Biketastic: Sensing and Mapping for Better Biking. In *CHI*, 2010.
- [17] R. Soames, C. Blake, J. Stott, A. Goodbody, and D. Brewerton. Measurement of pressure under the foot during function. *Medical and Biological Engineering and Computing*, 1982.
- [18] D. Trossen and D. Pavel. Building a ubiquitous platform for remote sensing using smartphones. In *MobiQuitous*, 2005.
- [19] University of Waterloo CA. Smart Orthotics. <http://www.engineering.uwaterloo.ca/~jgorchyn/>, Sept 2010.
- [20] A. Vees, H. Murray, M. Young, and A. Boulton. The risk of foot ulceration in diabetic patients with high foot pressure: a prospective study. *Diabetologia*, 35:660–663, 1992.