

DISCRETE EVENT SYSTEMS

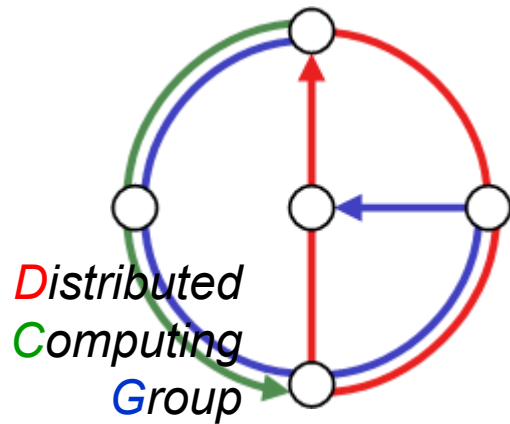

Christoph Stamm
Winter 2006 / 2007

Chapter 0

INTRODUCTION

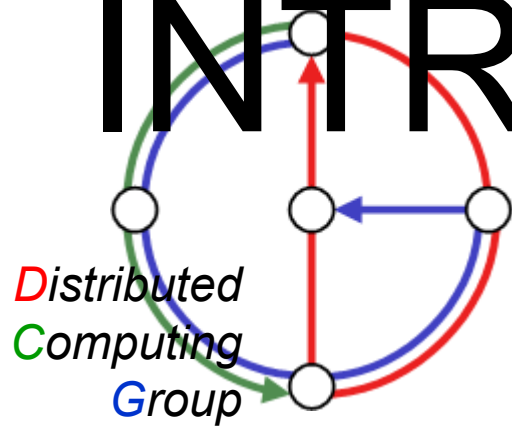

Discrete Event Systems
Winter 2006 / 2007

Organization Matters



- Lecture
 - Thu, 1-3, ETF E1
 - Christoph Stamm
- Exercises
 - Thu, 3-5, ETF E1
 - Roland Flury, Stefan Schmid, and others
- Course Material
 - Check dcg.ethz.ch/lectures/ws0607/eventsystems
 - Roger Wattenhofer / Christoph Stamm

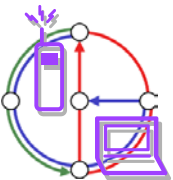

Course Overview

- Part 1: Theory of Coke Vending Machines
 - Automata and Languages
 - Discrete Event Systems (DES) Models
- Part 2: Theory of Standing in a Line
 - Stochastic Processes
 - Markov Chains, Queuing Theory
 - Average-Case Analysis of DES
- Part 3: Theory of Renting Skis
 - Online Algorithms
 - Worst-Case Analysis of DES
- Plus a few smaller parts

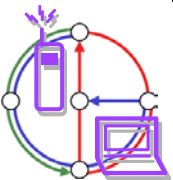

Motivation: Physics



- Science is often based on natural phenomena
- Laws of physics: mechanics, gravitation, electrodynamics
- Continuous variables for mass, velocity, power, etc.
- Can be solved by differential equations

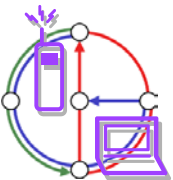
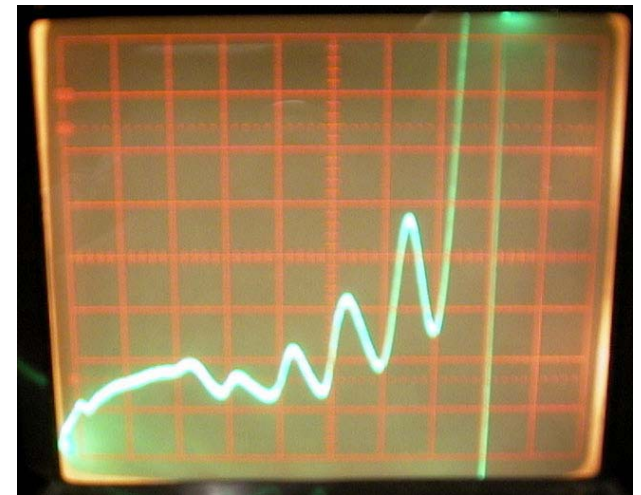

Motivation: Simple Modeling Process

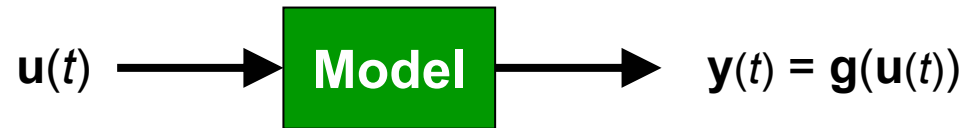
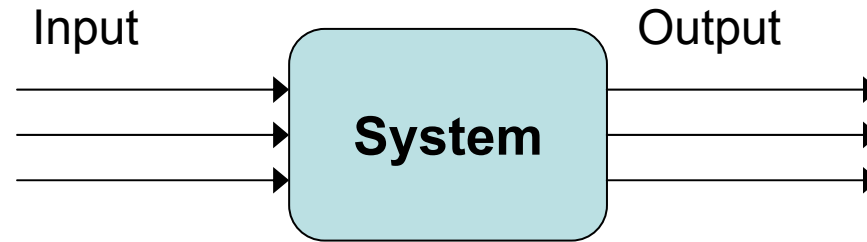

- Static example

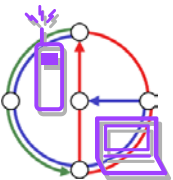
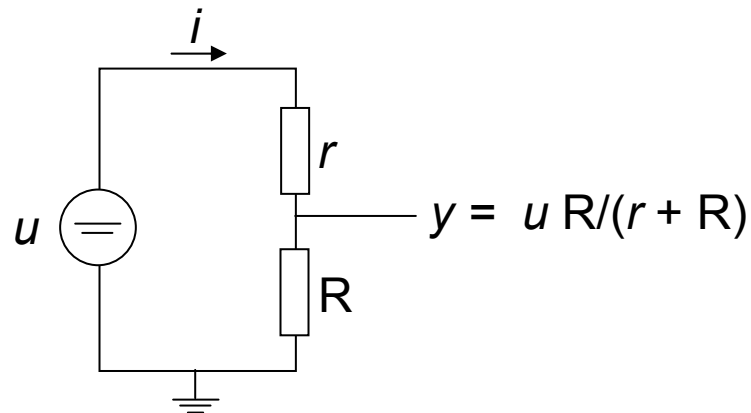

Motivation: State Space Modeling Process

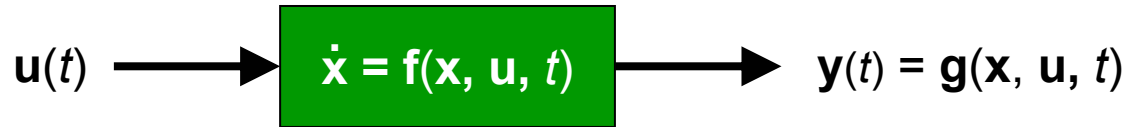

- Dynamic example

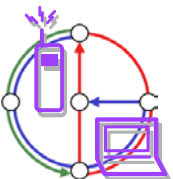
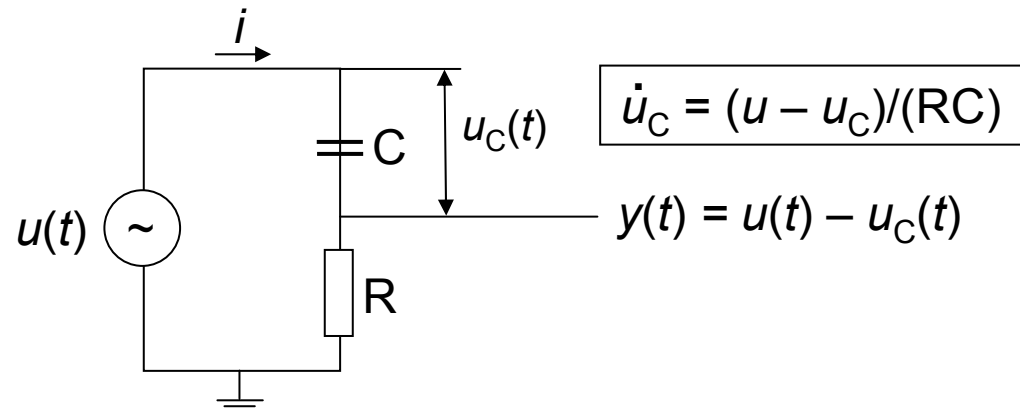

Motivation: Discrete Events

- Some complex systems are not [primarily/only] continuous

- Computer systems
- Communication networks
- Business processes (“workflow”)
- Transportation systems
- Software



- Instead systems are determined by discrete events

- Telephone calls
- Customers arrivals

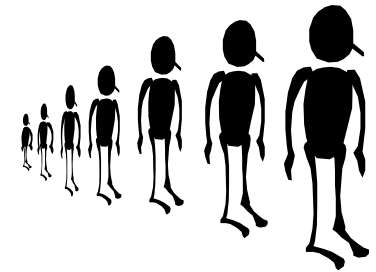

- Many variables we are interested in are discrete

- „How many ...?“

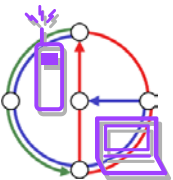

Motivation: Discrete Event Systems



- System models
 - Find the right level of detail to model a real system
 - “Make everything as simple as possible, but not simpler”
- Correctness verification
 - Formal specification
 - Testing
 - Simulation
- Analysis and Optimization

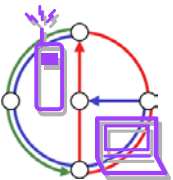

Motivation: System Classification

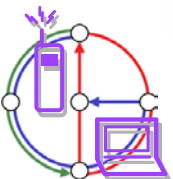
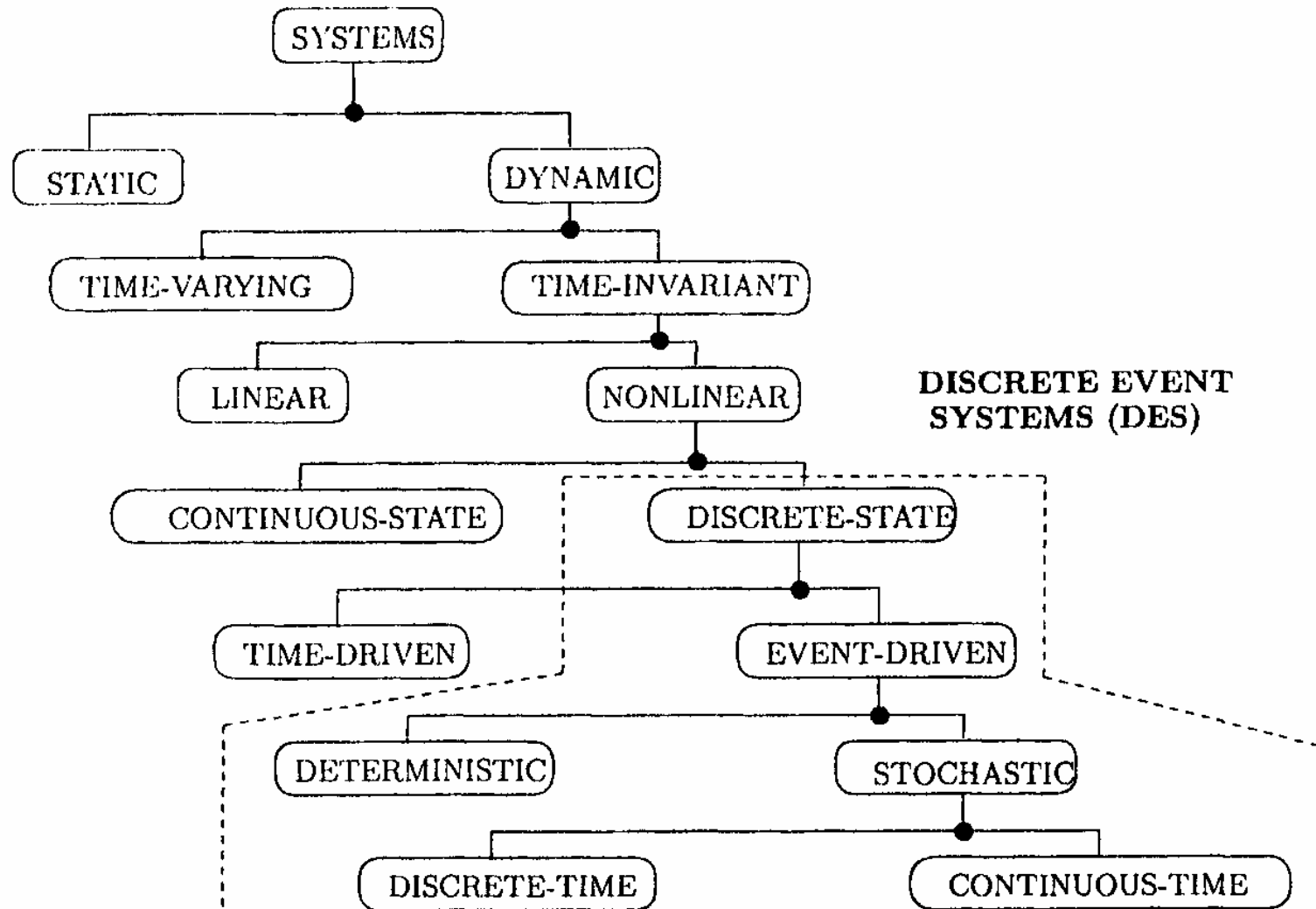

Literature



- Christos G. Cassandras, Stephane Lafortune. Introduction to Discrete Event Systems. Kluwer Academic Publishers, 1999.
- **Part 1**
 - Michael Sipser. Introduction to the Theory of Computation. PWS Publishing, 1997. (Chapters 1 and 2)
- **Part 2**
 - Dimitri Bertsekas, Robert Gallager. Data Networks. Prentice Hall, Upper Saddle River, NJ, 1992. (Chapter 3)
 - Thomas Schickinger, Angelika Steger: Diskrete Strukturen, Band 2. Springer, 2001. (Chapters 1, 2, and 4)
- **Part 3**
 - Allan Borodin, Ran El-Yaniv. Online Computation and Competitive Analysis. Cambridge University Press, 1998. (Selected Chapters)
- Plus lots of research papers...

