

Discrete Event Systems

Solution to Exercise Sheet 1

1 Finite Automata

a) The following machine accepts all strings of the form $1^*0^*11^*$.

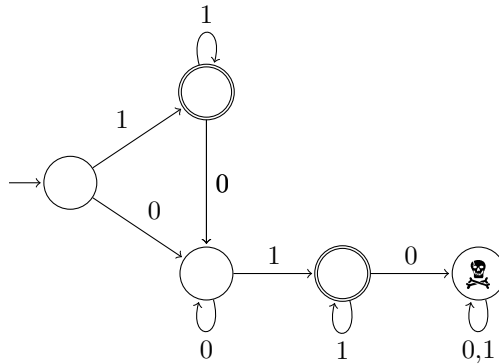

b) We use the fact that a number is divisible by three if and only if its cross sum (in German: *Quersumme*) is divisible by three. Our automaton has three states that denote the value of the cross sum computed so far modulo 3.

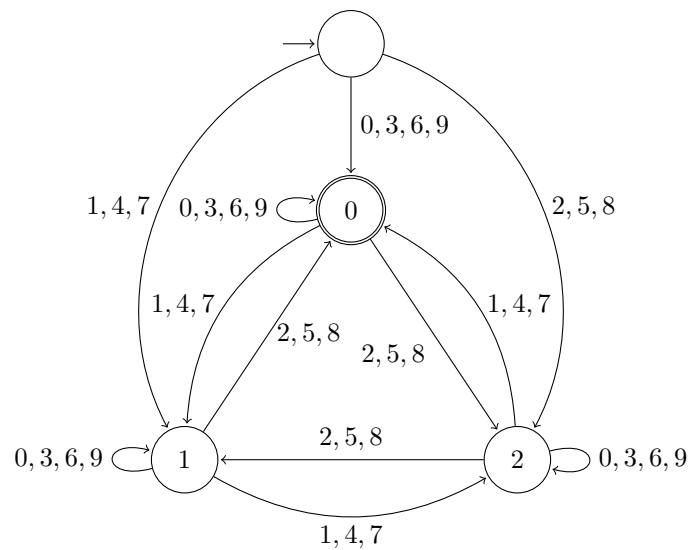

2 Vending Machine Revisited

If \$0.30 or \$0.40 have been inserted (states “30” and “40”), it is not possible anymore to reach state “45” by inserting dimes or quarters; thus, once in these “bad” states, no soda will ever be dispensed again.

One can think of several ways to circumvent this problem. For example, an additional button could be introduced at the machine which allows the user to return to state “0”, ejecting the coins accumulated so far. Another solution would be to allow 5 cent coins.

3 “Mais im Bundeshuus”

- a) The automaton accepts if and only if at least four members of the Swiss Federal Council vote in favor of the proposition. The following machine remembers the number of approving votes.

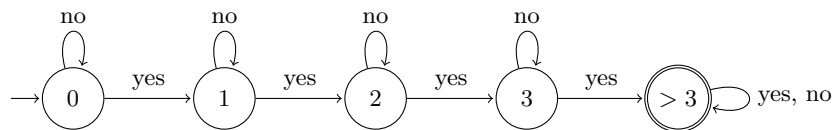

- b) We consider the alphabet {yes, no, ?}, where “?” denotes abstention of voting.

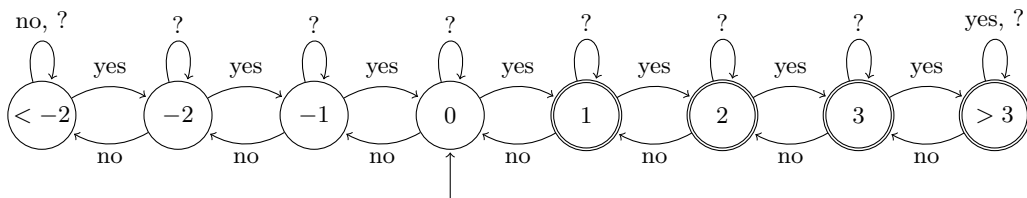

4 Build Finite Automata with the Construction Rules

- a) The following are finite automata for the two languages $\{w \mid w \text{ has exactly two a's}\}$ and $\{w \mid w \text{ has at least two b's}\}$.

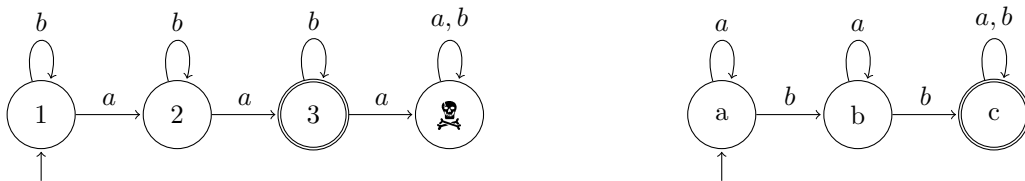

Combining them using the intersection construction gives the following finite automaton.

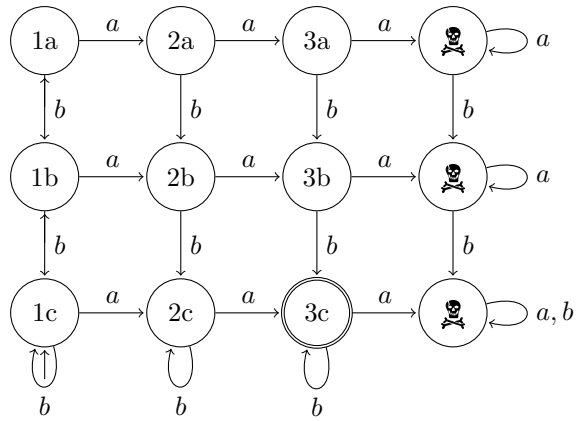

b) This finite automaton accepts $\{w \mid w \text{ contains } \mathbf{baba}\}$.

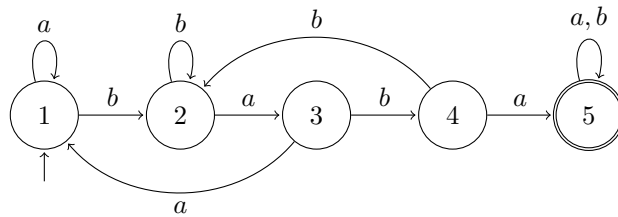

Its complement accepts $\{w \mid w \text{ does not contain } \mathbf{baba}\}$.

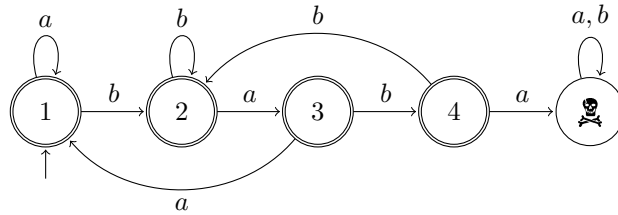

5 Exam question [2015]

The intuition is that when we read a new digit, it is like if we do a bit shift to the left. If the new digit is a 0, it is like if we multiply the number by two. If the new digit is a 1, it is like if we multiply the number plus one.

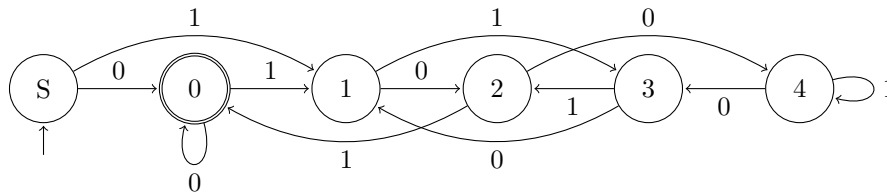

6 Filter for an Input Stream

The following figure gives an example with four states.

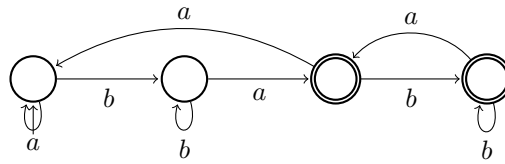

The main idea here is to use two different accepting states after having read a : one for zero b 's and one for more than zero b 's.